

(NOTE: PREMIER LOCKER SHOWN WITHOUT SIDE PANEL OR SLOPING HOOD. PLEASE ORDER SEPERATELY.)

MODEL #15-42364
 15" WIDE DOUBLE TIER
 PREMIER WOOD LOCKER – 3 WIDE
 WITH STANDARD HASPS

(6) LOCKER COMPARTMENTS
 EACH COMPARTMENT:
 13-3/4" W x 34-3/4" H x 22-3/4" D

SIDE VIEW

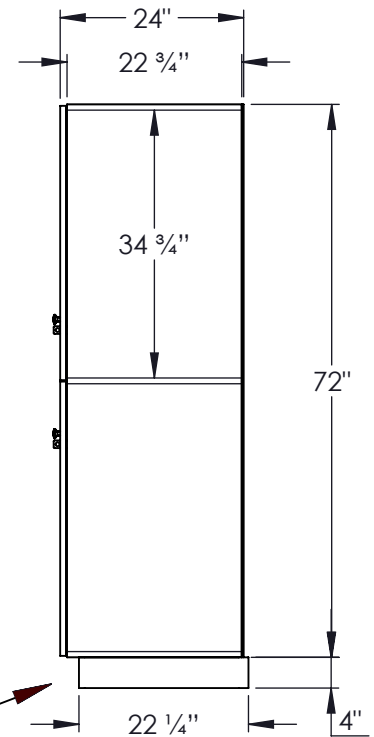

(BASES ARE MADE OF INDUSTRIAL GRADE PARTICLEBOARD AND ARE COVERED IN A DURABLE BLACK LAMINATE. PLEASE SET BASE TO ALLOW 5/8" BETWEEN THE BACK OF THE LOCKER AND THE WALL FOR AIR VENTILATION.)

MODEL #15-42364

15" WIDE DOUBLE TIER
 PREMIER WOOD LOCKER
 WITH STANDARD HASPS
 SIX FEET HIGH (ADD 4" FOR BASE)

AVAILABLE FINISHES: ARCTIC WHITE, WINTER FOG,
 CARBON MESH, SILVER TEAK, RED OAK, SKYLINE WALNUT

DRAWN: 4/2024

18300 CENTRAL AVENUE
 CARSON, CA 90746-4008
 PHONE: (800) 562-5377
 FAX: (800) 562-5399
 email: engineering@lockers.com