

MODEL #77778
 96" WIDE ALUMINUM LOCKER BENCH
 96" W x 18" H x 10" D

MODEL #77778

96" WIDE ALUMINUM LOCKER BENCH

DRAWN: 3/2020

Established in 1936, Salsbury Industries is the industry leader in manufacturing and distributing quality lockers.

18300 CENTRAL AVENUE
 CARSON, CA 90746-4008
 PHONE: (800) 562-5377
 FAX: (800) 562-5399
 email: engineering@lockers.com

MODEL #77773
36" W x 18" H x 10" D

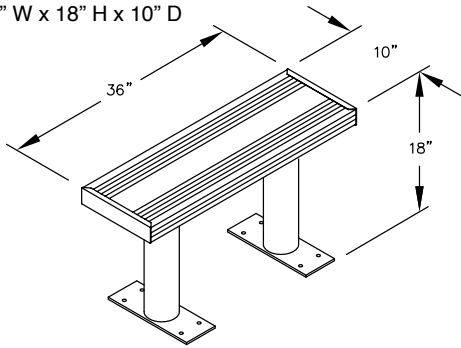

MODEL #77774
48" W x 18" H x 10" D

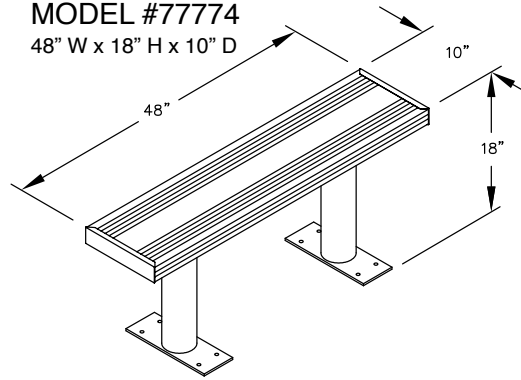

MODEL #77775
60" W x 18" H x 10" D

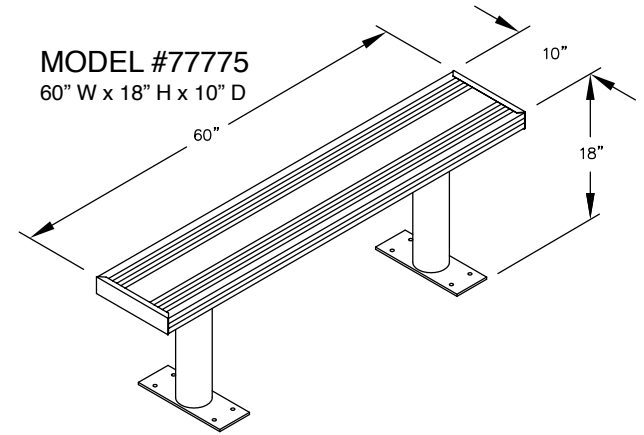

MODEL #77776
72" W x 18" H x 10" D

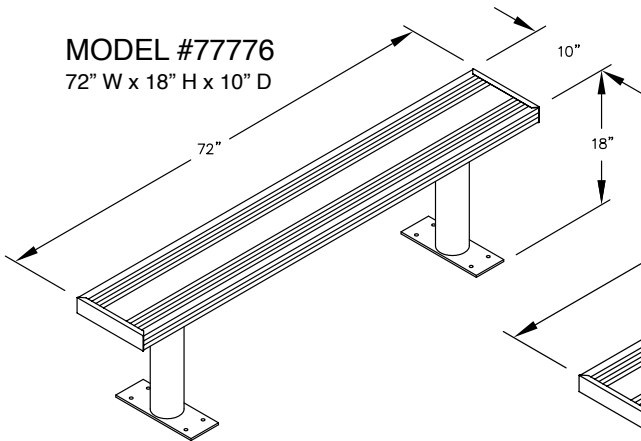

MODEL #77777
84" W x 18" H x 10" D

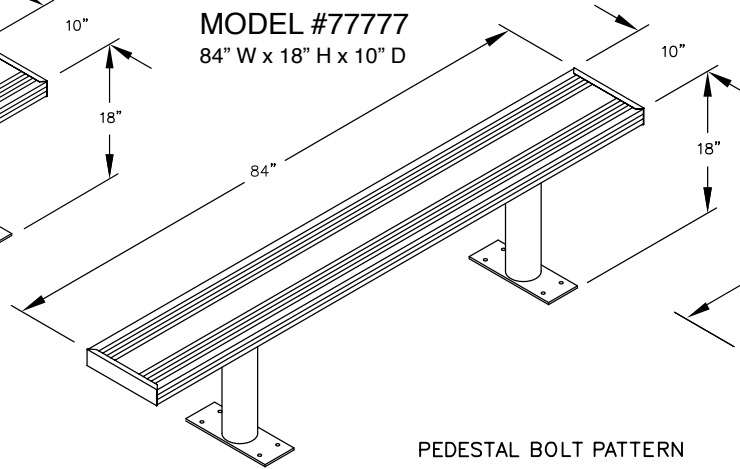

MODEL #77778
96" W x 18" H x 10" D

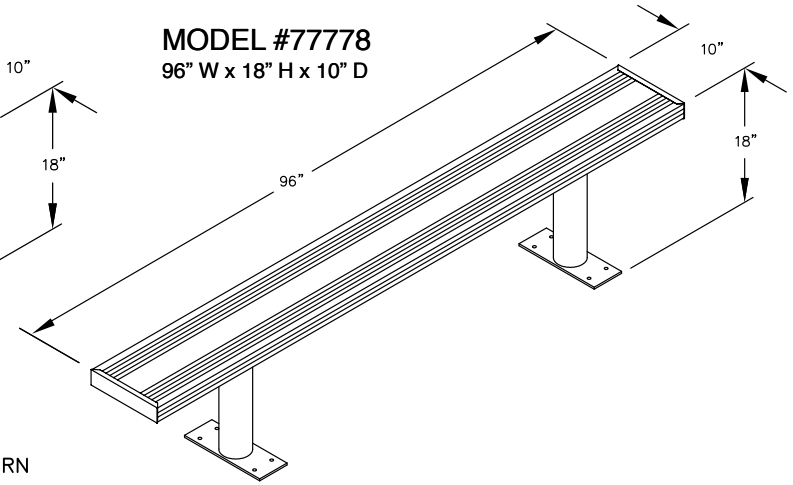

PEDESTAL BOLT PATTERN

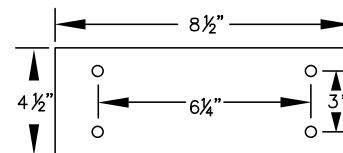

ALUMINUM LOCKER BENCHES

- MODEL #77773 (36" Wide)
- MODEL #77774 (48" Wide)
- MODEL #77775 (60" Wide)
- MODEL #77776 (72" Wide)
- MODEL #77777 (84" Wide)
- MODEL #77778 (96" Wide)

DRAWN: 7/2020

Established in 1936, Salsbury Industries is the industry leader in manufacturing and distributing quality lockers.

18300 CENTRAL AVENUE
CARSON, CA 90746-4008
PHONE: (800) 562-5377
FAX: (800) 562-5399
email: engineering@lockers.com